

CHICAGO

Electric[®] Power Tools

18 VOLT CORDLESS DRILL

Model 65930

OPERATING INSTRUCTIONS



Distributed exclusively by Harbor Freight Tools[®].

3491 Mission Oaks Blvd., Camarillo, CA 93011

Visit our website at: <http://www.harborfreight.com>



Read this material before using this product.

Failure to do so can result in serious injury.

SAVE THIS MANUAL.

Copyright[®] 2007 by Harbor Freight Tools[®]. All rights reserved. No portion of this manual or any artwork contained herein may be reproduced in any shape or form without the express written consent of Harbor Freight Tools. Diagrams within this manual may not be drawn proportionally. Due to continuing improvements, actual product may differ slightly from the product described herein. Tools required for assembly and service may not be included.

For technical questions or replacement parts, please call 1-800-444-3353.

PRODUCT SPECIFICATIONS

Power Source	18 VDC, 1.3 Ah, NiCd Battery
Charge Time	5 hours (Initial) 3-5 hours (Recharging)
Charger Input	120 VAC / 60 Hz / 300 W
Chuck Type	1/2" Single Sleeve Keyless
Torque Settings	16
Variable Speed	0-900 RPM
Maximum Torque	6 ft./lb.
Reversible	Yes
Trigger Lock	Yes
Weight	5.5 Pounds

Save This Manual

You will need this manual for the safety warnings and precautions, assembly, operating, inspection, maintenance and cleaning procedures, parts list and assembly diagram. Keep your invoice with this manual. Write the invoice number on the inside of the front cover. Keep this manual and invoice in a safe and dry place for future reference.

GENERAL SAFETY RULES

WARNING!

READ AND UNDERSTAND ALL INSTRUCTIONS
Failure to follow all instructions listed below may result
in electric shock, fire, and/or serious injury.
SAVE THESE INSTRUCTIONS

Work Area

1. **Keep your work area clean and well lit.** Cluttered benches and dark areas invite accidents.
2. **Do not operate power tools in explosive atmospheres, such as in the presence of flammable liquids, gases, or dust.** Power tools create sparks which may ignite the dust or fumes.
3. **Keep bystanders and children away while operating a power tool.** Distractions can cause you to lose control. Protect others in the work area from debris such as chips and sparks. Provide barriers or shields as needed.

Electrical Safety

1. **Grounded tools must be plugged into an outlet properly installed and grounded in accordance with all codes and ordinances. Never remove the grounding prong or modify the plug in any way. Do not use any adapter plugs. Check with a qualified electrician if you are in doubt as to whether the outlet is properly grounded.** If the tools should electrically malfunction or break down, grounding provides a low resistance path to carry electricity away from the user.
2. **Double insulated tools are equipped with a polarized plug (one blade is wider than the other). This plug will fit in a polarized outlet only one way. If the plug does not fit fully in the outlet, reverse the plug. If it still does not fit, contact a qualified electrician to install a polarized outlet. Do not change the plug in any way.** Double insulation eliminates the need for the three wire grounded power cord and grounded power supply system.
3. **Avoid body contact with grounded surfaces such as pipes, radiators, ranges, and refrigerators.** There is an increased risk of electric shock if your body is grounded.
4. **Do not expose power tools to rain or wet conditions.** Water entering a power tool will increase the risk of electric shock.
5. **Do not abuse the Charger's power cord. Never use the Power Cord to carry the Charger or pull the Plug from an outlet. Keep the Power Cord away from heat, oil, sharp edges, or moving parts. Replace damaged Power Cords immediately.** Damaged Power Cords increase the risk of electric shock.

Personal Safety

1. **Stay alert. Watch what you are doing, and use common sense when operating a power tool. Do not use a power tool while tired or under the influence of drugs, alcohol, or medication.** A moment of inattention while operating power tools may result in serious personal injury.
2. **Dress properly. Do not wear loose clothing or jewelry. Contain long hair. Keep your hair, clothing, and gloves away from moving parts.** Loose clothes, jewelry, or long hair can be caught in moving parts.
3. **Avoid accidental starting. Be sure the Rotation Button (9) is in the locked position before inserting the Battery.** Carrying power tools with your finger on the trigger, or inserting the Battery with the trigger depressed, invites accidents.
4. **Do not overreach. Keep proper footing and balance at all times.** Proper footing and balance enables better control of the power tool in unexpected situations.

5. **Use safety equipment. Always wear eye protection.** Dust mask, nonskid safety shoes, hard hat, or hearing protection must be used for appropriate conditions. Always wear ANSI-approved safety goggles when working with this tool.

Tool Use and Care

1. **Use clamps (not included) or other practical ways to secure and support the workpiece to a stable platform.** Holding the work by hand or against your body is unstable and may lead to loss of control.
2. **Do not force the tool. Use the correct tool for your application.** The correct tool will do the job better and safer at the rate for which it is designed.
3. **Do not use the power tool if the trigger does not operate it.** Any tool that cannot be controlled with the trigger is dangerous and must be replaced.
4. **Remove the battery from the tool and set the Rotation Button (9) to the center, locked position, before making any adjustments, changing accessories, or storing the tool.** These preventive safety measures reduce the risk of starting the tool accidentally.
5. **Store idle tools out of reach of children and other untrained persons.** Tools are dangerous in the hands of untrained users.
6. **Maintain tools with care. Keep drill bits (not included) sharp and clean.** Properly maintained accessories with a sharp cutting edge are less likely to bind and are easier to control. Do not use a damaged tool or accessory. Tag damaged tools "Do not use" until repaired.
7. **Check for misalignment or binding of moving parts, breakage of parts, and any other condition that may affect the tool's operation. If damaged, have the tool serviced before using.** Many accidents are caused by poorly maintained tools.
8. **Use only accessories that are recommended by the manufacturer for your model.** Accessories that may be suitable for one tool may become hazardous when used on another tool.

Service

1. **Tool service must be performed only by qualified repair personnel.** Service or maintenance performed by unqualified personnel could result in a risk of injury.
2. **When servicing a tool, use only identical replacement parts. Follow instructions in this manual.** Use of unauthorized parts or failure to follow maintenance instructions may create a risk of electric shock or injury.

SPECIFIC SAFETY RULES

1. **Maintain a safe working environment.** Keep the work area well lit. Make sure there is adequate surrounding workspace. Always keep the work area free of obstructions, grease, oil, trash, and other debris. Do not use the Cordless Drill in areas near flammable chemicals, dusts, and vapors. Do not use this product in a damp or wet location.
2. **Maintain labels and nameplates on the Cordless Drill.** These carry important information. If unreadable or missing, contact Harbor Freight Tools for a replacement.
3. **When using the Cordless Drill, always maintain a firm grip on the tool with both hands.**
4. **Hold the tool by its insulated gripping surfaces when performing an operation where the Cordless Drill may contact hidden wiring.** Contact with a “live” wire will make exposed metal parts of the Cordless Drill “live” and shock the operator.
5. **Do not use the Cordless Drill or Charger (29) if it has been dropped, damaged, left outdoors, or immersed in liquid.**
6. **To avoid electric shock, do not pull or carry the Charger by its Power Cord or pull the Power Cord around sharp corners or edges.** Do not unplug the Charger by pulling on the Power Cord. Keep the Power Cord away from heated surfaces.
7. **To avoid electrical shock, do not handle the Charger, the Adapter (30), or the Cordless Drill with wet hands.**
8. **Keep the Handles of the Cordless Drill dry, clean, and free from oil or grease.**
9. **Avoid unintentional starting.** Make sure you are prepared to begin work before turning on the Cordless Drill.
10. **Never leave the Charger unattended when it is plugged into an electrical outlet.** Unplug the Charger from its electrical outlet before leaving.
11. **PROPER BATTERY PACK CARE: Battery Pack (28) leakage may occur under extreme usage or temperature conditions.** If Battery Pack fluid comes in contact with skin, rinse with lemon juice and vinegar then wash with soap and water. If the fluid comes into contact with the eyes, flush with water for several minutes and contact a doctor immediately. Never burn the Battery Pack, as it can explode in a fire. Do not charge the Cordless Drill with a leaking Battery Pack. Contact local solid waste authorities for instructions on correct disposal or recycling of the Battery Pack.
12.  **WARNING!** Some dust created by power sanding, sawing, grinding, drilling, and other construction activities, contain chemicals known (to the State of California) to cause cancer, birth defects or other reproductive harm. Some examples of these chemicals are: lead from lead-based paints, crystalline silica from bricks and cement or other masonry products, arsenic and chromium from chemically treated lumber.

Your risk from these exposures varies, depending on how often you do this type of work. To reduce your exposure to these chemicals: work in a well ventilated area, and work with approved safety equipment, such as dust masks that are specially designed to filter out microscopic particles. (California Health & Safety Code § 25249.5, *et seq.*)

13. **⚠️ WARNING!** People with pacemakers should consult their physician(s) before using this product. Operation of electrical equipment in close proximity to a heart pacemaker could cause interference or failure of the pacemaker.

GROUNDING

⚠️ WARNING!

Improperly connecting the grounding wire can result in the risk of electric shock. Check with a qualified electrician if you are in doubt as to whether the outlet is properly grounded. Do not modify the power cord plug provided with the tool. Never remove the grounding prong from the plug. Do not use the tool if the power cord or plug is damaged. If damaged, have it repaired by a service facility before use. If the plug will not fit the outlet, have a proper outlet installed by a qualified electrician.

GROUNDING TOOLS: TOOLS WITH THREE PRONG PLUGS

1. Tools marked with “Grounding Required” have a three wire cord and three prong grounding plug. The plug must be connected to a properly grounded outlet. If the tool should electrically malfunction or break down, grounding provides a low resistance path to carry electricity away from the user, reducing the risk of electric shock. **(See Figure A.)**
2. The grounding prong in the plug is connected through the green wire inside the cord to the grounding system in the tool. The green wire in the cord must be the only wire connected to the tool’s grounding system and must never be attached to an electrically “live” terminal. **(See Figure A.)**
3. Your tool must be plugged into an appropriate outlet, properly installed and grounded in accordance with all codes and ordinances. The plug and outlet should look like those in the following illustration. **(See Figure A.)**

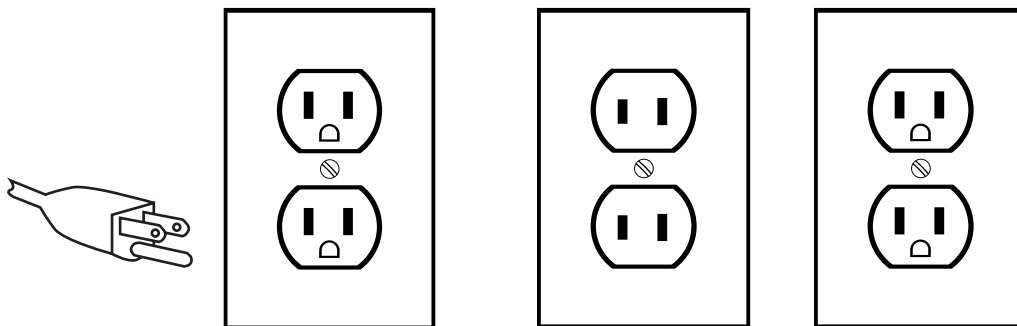







FIGURE A

FIGURE B.

DOUBLE INSULATED TOOLS: TOOLS WITH TWO PRONG PLUGS

1. Tools marked “Double Insulated” do not require grounding. They have a special double insulation system which satisfies OSHA requirements and complies with the applicable standards of Underwriters Laboratories, Inc., the Canadian Standard Association, and the National Electrical Code. **(See Figure B.)**
2. Double insulated tools may be used in either of the 120 volt outlets shown in the preceding illustration. **(See Figure B.)**

SYMBOLOLOGY

	Double Insulated
	Canadian Standards Association
	Underwriters Laboratories, Inc.
	Volts Alternating Current
	Amperes
	No Load Revolutions per Minute (RPM)

UNPACKING

When unpacking, check to make sure that the product is complete and undamaged. If any parts are missing or broken, please call Harbor Freight Tools at the number shown on the cover of this manual as soon as possible.

CHARGING

1. NOTE: The Battery Pack (28) requires charging before first use. The first charge requires a **5 hour** charge prior to initial use of the Cordless Drill.
2. Note: Always switch to a fresh battery when tool performance begins to diminish. Severe heat is most destructive to a battery; the more heat generated, the faster the battery loses power. A battery that gets too hot can be permanently damaged. Never over-discharge a battery by using the tool after its' performance is decreasing. Never attempt to discharge a tool's battery by continuing to pull the trigger. When tool performance begins to diminish, stop the tool, recharge the battery and use the fresh battery for optimal performance.
3. When the Battery Pack requires recharging, a **3-5 hour** charge allows the tool to operate at full power.
4. Charging room temperature: 50° F. – 104° F.
5. Depress both buttons at the rear of each side of the Battery Pack and slide unit back to detach from the Drill. Plug Battery Pack into Adapter (30) the same way it plugs into the Cordless Drill, then slide Adapter onto Charger (29), and plug the Charger into the nearest 120 volt, grounded, electrical outlet.
6. While charging, the Battery Pack, Charger, and Adapter may become warm to the touch. This is normal, and does not indicate a problem.
7. Once the Battery Pack is fully charged, disconnect the Charger from the electrical outlet. Disconnect the Adapter and the Battery Pack from the Charger.

OPERATING INSTRUCTIONS

NOTE: For additional information regarding the parts listed in the following pages, refer to the **Assembly Diagram on page 13**.

⚠ WARNING! Remove the Battery (28) from the tool and set the Rotation Button (9) to its center, locked, position before making any adjustments, changing accessories, or storing the tool.



Figure E.

1. To install a drill/screwdriver bit: with the chuck pointing away from you, hold the Chuck Sleeve firmly in place and turn the Chuck (16) counterclockwise. Insert the shank of the bit all the way into the Chuck. While holding the Chuck Sleeve in place, turn the Chuck clockwise to lock the bit in place. The Chuck accepts up to 1/2" diameter bits. Insert the appropriate bit for your application and tighten the Chuck firmly. (See Figure E., above.)
2. Secure the workpiece in place, using a vise or clamps (not included).

Warning! Never change Torque Setting while drill is still rotating, as this can damage the drill.

3. Decide on which setting to choose for application:

Torque Settings (1-16):

The different numbers on the Ring are an indication of how much torque the screwdriver will apply to the bit before the clutch slips, allowing the bit to stop and

helping to prevent damage to the screw, bit, or workpiece. The higher the number, the more torque is applied before the clutch slips. Unless you are drilling, always start with a lower number to help prevent damage. This drill also has torque settings between the numbers to allow a greater range of control.

Drill Setting :

This setting essentially prevents the clutch from slipping entirely. It is designed for drilling, but is not advised for using the screwdriver because it offers no protection against stripping the head or splitting the wood.

4. Set the drilling torque by turning the Torque Setting Ring (15) to align the torque indicator arrow with the desired setting. (See Figure E., previous page.)
5. When drilling in light gauge metal or wood, use a wooden block to back up the material to prevent damage to the workpiece.
6. Mark the center of the hole to be drilled with a center punch (not included) to give a Drill Bit a start and to prevent it from “walking”.
7. Lubricate the Drill Bit with cutting oil (not included) when drilling iron or steel. Use a coolant (not included) when drilling nonferrous metals such as copper, brass, or aluminum.
8. Attach the Accessory Grip (14) to the drill by sliding the metal loop over the front of the drill and fastening it securely behind the Torque Setting. Turn the handle of Accessory Grip clockwise until it holds firmly. The Accessory Grip allows greater control over the Drill and makes it easier to resist being pulled out of alignment by torque.
9. Insert the fully charged Battery Pack (28) into the Handle of the Cordless Drill.
10. The Rotation Button (9) allows you to change the rotational direction of the Cordless Drill. For a clockwise rotation, move the Rotation Button to the right. For a counterclockwise rotation, move the Rotation Button to the left. The center position locks the Trigger (10), helping to prevent the Drill from operating. The Forward/Reverse Indicator (21) lights up, when the Trigger is depressed, to show which direction the Drill is set.
11. Make sure to hold the Cordless Drill firmly with both hands, as torque from the Motor can cause the tool to twist.
12. Operate the Drill, by squeezing the Trigger (10). The speed of the Drill can be controlled by varying the pressure on the Trigger.
13. If Drilling:
Use the Drill torque setting, as described above.

Drill only as deep as necessary. Do not drill deeper than necessary into walls or other areas where you cannot identify any possible hazards behind the drilling surface.

To reduce jamming as the Bit breaks through the workpiece, decrease the drilling pressure when the point of the Bit breaks through the workpiece.

14. When you have drilled the hole, remove the Bit from the hole while the Cordless Drill is still running. This prevents the Bit from getting caught in the hole and causing damage.
15. When driving screws, start with a low torque setting.
16. If the clutch starts slipping before the screw is in all the way, stop the drill, put the Rotation Button (9) in the center position and change the torque setting. Reset the rotation direction before continuing.
17. Release the Trigger (10) to stop the Drill. Then, remove the Battery Pack, put the Rotation Button in the center position, and remove the bit from the Drill.

INSPECTION, MAINTENANCE, AND CLEANING

1.  **WARNING! Remove the Battery Pack (28) from the tool and set the Rotation Button (9) to its center, locked position before performing any inspection, maintenance, or cleaning.**
2. **BEFORE EACH USE**, inspect the general condition of the Cordless Drill. Check for misalignment or binding of moving parts, cracked or broken parts, leaking Battery Pack, damaged Charger wiring, chipped or broken Drill Bits, and any other condition that may affect its safe operation. If abnormal noise or vibration occurs, have the problem corrected before further use.
Do not use damaged equipment.
3. **DAILY:** With a soft brush or cloth, remove all dirt and debris from the Cordless Drill. Do not immerse the Cordless Drill in any liquids.
4. **When the battery needs replacement keep in mind that the Nickel-Cadmium (Ni-Cd) battery in this tool must be recycled or disposed of properly.**

PARTS LIST

Part	Description	QTY
1	Screw	2
2	Sticker	1
3	2-Head Bit	1
4	Plate	1
5	Battery Indicator Button	1
6	Bit Clamp	1
7	Battery Indicator PCB	1
8	Left Shell	1
9	Rotation Button	1
10	Trigger	1
11	R/R Indicator PCB	1
12	Magnesium Shell	1
13	Screw	1
14	Accessory Grip	1
15	Torque Setting Ring	1

Part	Description	QTY
16	Chuck (13mm)	1
17	Screw	1
18	Gear Assembly Motor	1
19	Right Shell	1
20	Cover	1
21	Forward/Reverse Indicators	1
22	Level Vial	1
23	Screw	1
24	Insulated Pipe	1
25	Battery Clamp Housing	1
26	Wire	8
27	Battery Clamp	1
28	Battery Pack	1
29	Charger (not shown)	1
30	Adapter (not shown)	1

ASSEMBLY DIAGRAM

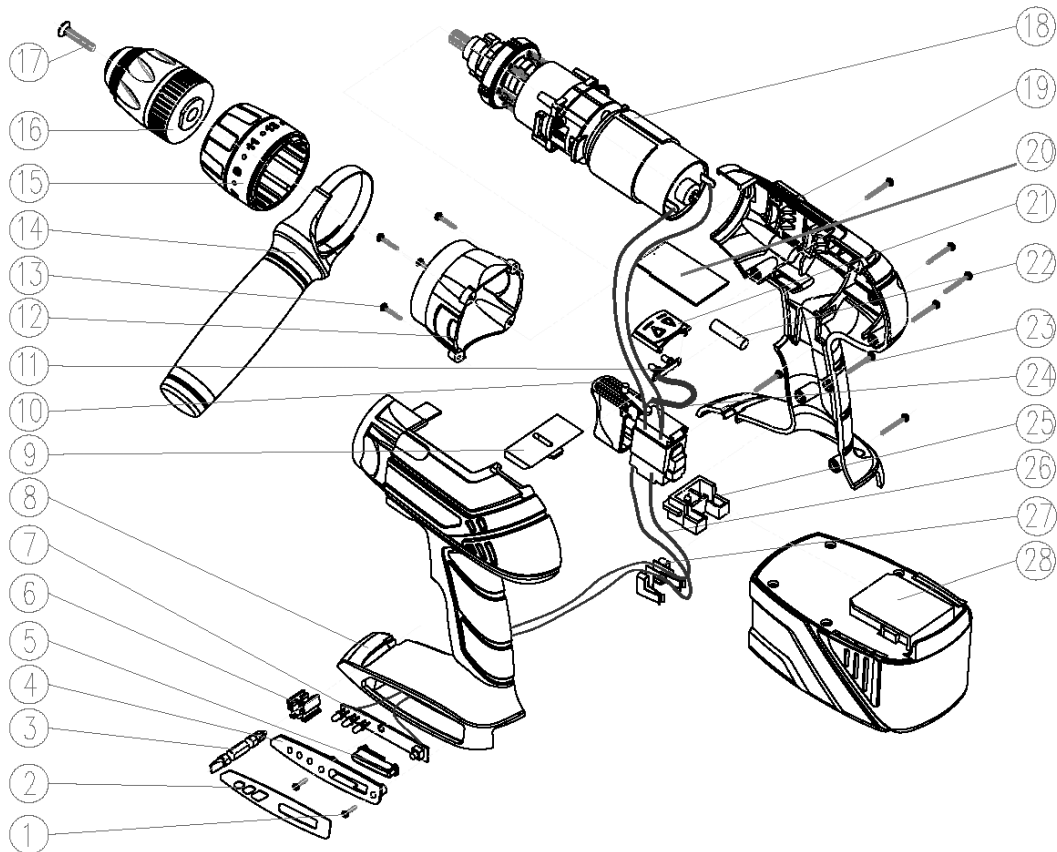

PLEASE READ THE FOLLOWING CAREFULLY

THE MANUFACTURER AND/OR DISTRIBUTOR HAS PROVIDED THE PARTS LIST AND ASSEMBLY DIAGRAM IN THIS MANUAL AS A REFERENCE TOOL ONLY. NEITHER THE MANUFACTURER OR DISTRIBUTOR MAKES ANY REPRESENTATION OR WARRANTY OF ANY KIND TO THE BUYER THAT HE OR SHE IS QUALIFIED TO MAKE ANY REPAIRS TO THE PRODUCT, OR THAT HE OR SHE IS QUALIFIED TO REPLACE ANY PARTS OF THE PRODUCT. IN FACT, THE MANUFACTURER AND/OR DISTRIBUTOR EXPRESSLY STATES THAT ALL REPAIRS AND PARTS REPLACEMENTS SHOULD BE UNDERTAKEN BY CERTIFIED AND LICENSED TECHNICIANS, AND NOT BY THE BUYER. THE BUYER ASSUMES ALL RISK AND LIABILITY ARISING OUT OF HIS OR HER REPAIRS TO THE ORIGINAL PRODUCT OR REPLACEMENT PARTS THERETO, OR ARISING OUT OF HIS OR HER INSTALLATION OF REPLACEMENT PARTS THERETO.

LIMITED 1 YEAR WARRANTY

Harbor Freight Tools Co. makes every effort to assure that its products meet high quality and durability standards, and warrants to the original purchaser that this product is free from defects in materials and workmanship for the period of one year from the date of purchase (90 days if used by a professional contractor or if used as rental equipment). This warranty does not apply to damage due directly or indirectly, to misuse, abuse, negligence or accidents, repairs or alterations outside our facilities, normal wear and tear, or to lack of maintenance. We shall in no event be liable for death, injuries to persons or property, or for incidental, contingent, special or consequential damages arising from the use of our product. Some states do not allow the exclusion or limitation of incidental or consequential damages, so the above limitation of exclusion may not apply to you. THIS WARRANTY IS EXPRESSLY IN LIEU OF ALL OTHER WARRANTIES, EXPRESS OR IMPLIED, INCLUDING THE WARRANTIES OF MERCHANTABILITY AND FITNESS.

To take advantage of this warranty, the product or part must be returned to us with transportation charges prepaid. Proof of purchase date and an explanation of the complaint must accompany the merchandise. If our inspection verifies the defect, we will either repair or replace the product at our election or we may elect to refund the purchase price if we cannot readily and quickly provide you with a replacement. We will return repaired products at our expense, but if we determine there is no defect, or that the defect resulted from causes not within the scope of our warranty, then you must bear the cost of returning the product.

This warranty gives you specific legal rights and you may also have other rights which vary from state to state.

3491 Mission Oaks Blvd. • PO Box 6009 • Camarillo, CA 93011 • (800) 444-3353

Record Product's Serial Number Here: _____

Note: If product has no serial number, record month and year of purchase instead.

Note: Some parts are listed and shown for illustration purposes only, and are not available individually as replacement parts.